



Dynalite Leading Edge Dimmers

DDLE802

8 channel Leading Edge Dimmer Controller at 2 A per channel

The Philips Dynalite DDLE802 is an eight channel leading edge dimmer controller with a maximum load per channel of 2 A. - It is suitable for use with incandescent, low voltage, neon and selected fluorescent fixtures. - Optional manual override LED illuminated service switch Soft start and voltage regulation technologies Naturally ventilated Flexible mounting solution

Product data

General Information	
CE mark	CE mark
Remarks	Please download the Lighting - Product Data Sheet for more information and ordering options
EU RoHS compliant	Yes
Application Conditions	
Ambient temperature range	0 to +40 °C
Product Data	
Full product code	871016350500800

Order product name	DDLE802
EAN/UPC - Product	8710163505008
Order code	50500800
Numerator - Quantity Per Pack	1
Numerator - Packs per outer box	1
Material Nr. (12NC)	913703000009
Net Weight (Piece)	0.600 kg

Dynalite Leading Edge Dimmers

Dimensional drawing

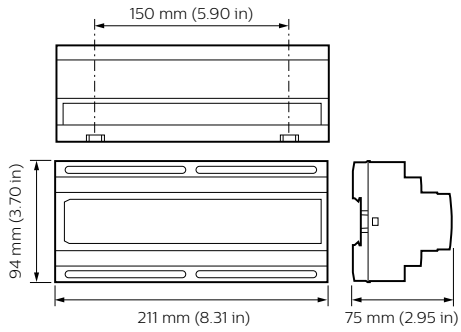

Dynalite Leading Edge Dimmers

