



Dynalite Network Accessories

DTK622-USB

Network gateway for passive integration to a PC or RS232 system. Also available as DTK622-232 (913703090109)

Network gateway for passive integration to a PC or RS232 system. Also available as DTK622-232 (913703090109)

Product data

General Information	
CE mark	CE mark
Remarks	Please download the Lighting - Product Data Sheet for more information and ordering options
EU RoHS compliant	Yes
Application Conditions	
Ambient temperature range	0 to +40 °C
Product Data	
Full product code	871016350804700

Order product name	DTK622-USB
EAN/UPC - Product	8710163508047
Order code	50804700
Numerator - Quantity Per Pack	1
Numerator - Packs per outer box	1
Material Nr. (12NC)	913703090209
Net Weight (Piece)	0.200 kg

Dynalite Network Accessories

Dimensional drawing

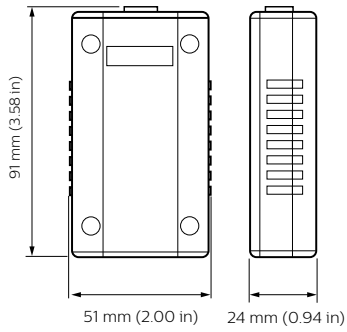

Dynalite Network Accessories

