



# MASTER LEDspot ExpertColor AR111



## MAS LEDspotLV D 20-100W 927 AR111 45D

MASTER LEDspot LV ExpertColor creates a warm and comfortable ambience for hospitality venues, homes and restaurants. It creates such an ambience with superior lighting that has a customized spectrum, high CRI, and deep dimming feature. The result? A beautiful lighting experience. What's more, the innovative, trimless lens design will suit almost any interior decor with its clean and neat look. In addition, you can take advantage of the full ExpertColor family, which also includes LEDspot MV and LEDspot Par lamps.

### Product data

General Information	
Cap-Base	G53 [G53]
Nominal lifetime	25,000 hour(s)
Switching Cycle	50,000
Lighting Technology	LED
Flux measurement reference	Narrow Cone
CE mark	Yes
EU RoHS compliant	Yes
Light Technical	
Color Code	927 [CCT of 2700K]
Beam Angle (Nom)	45 degree(s)
Luminous Flux	1,270 lumen
Luminous Intensity (Nom)	2,100 cd
Color Designation	Warm White (WW)
Correlated Color Temperature (Nom)	2700 K
Luminous Efficacy (rated) (Nom)	63.00 lm/W
Color Consistency	<4

Color rendering index (CRI)	91
LLMF At End Of Nominal Lifetime (Nom)	70 %
Luminous Flux in 90° Cone (Rated)	1,270 lumen
Photobiological safety according to EN 62471	RG1
Operating and Electrical	
Line Frequency	50 to 60 Hz
Input Frequency	50 to 60 Hz
Power Consumption	20 W
Lamp Current (Nom)	2,000 mA
Wattage Equivalent	100 W
Starting Time (Nom)	0.5 s
Warm-up time to 60% light	0.5 s
Power Factor (Fraction)	0.7
Voltage (Nom)	ac electronic 12 V

# MASTER LEDspot ExpertColor AR111

## Temperature

T-Case Maximum (Nom)	97 °C
----------------------	-------

## Controls and Dimming

Dimmable	Only with specific dimmers
----------	----------------------------

## Mechanical and Housing

Bulb Finish	Clear
Bulb Shape	AR111

## Approval and Application

Energy Efficiency Class	G
Suitable For Accent Lighting	Yes
Energy Consumption kWh/1000 h	20 kWh
EPREL Registration Number	648251
EyeComfort	Yes

## Product Data

Full product code	871869970513800
Order product name	MAS LEDspotLV D 20-100W 927 AR111 45D
Order code	70513800
Numerator - Quantity Per Pack	1
Numerator - Packs per outer box	6
Material Nr. (12NC)	929002050402
Full product name	MAS LEDspotLV D 20-100W 927 AR111 45D
EAN/UPC - Case	8719514275720
EAN/UPC - Product/Case	8718699705138

## Dimensional drawing

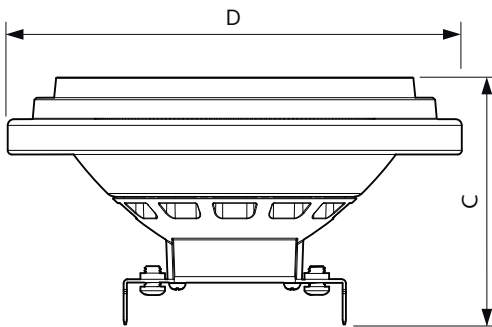

Product	D	C
MAS LEDspotLV D 20-100W 927 AR111 45D	111 mm	62 mm

## Photometric data

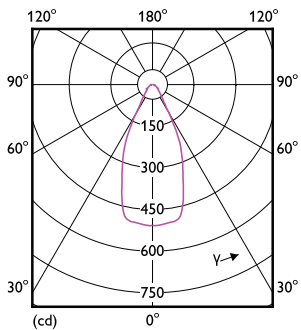

Light Distribution Diagram - MAS LEDspotLV D 20-100W 927 AR111 45D

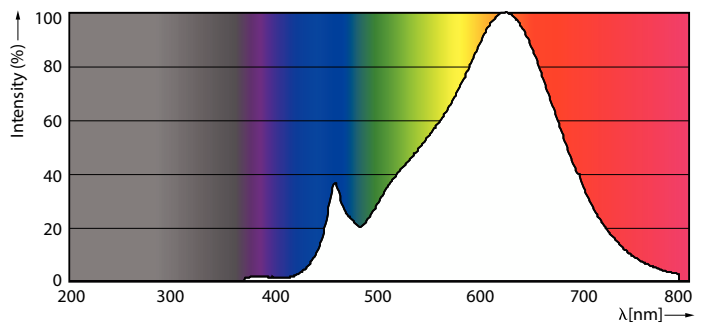

Spectral Power Distribution Colour - MAS LEDspotLV D 20-100W 927 AR111 45D

# MASTER LEDspot ExpertColor AR111

## Photometric data

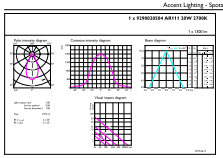

© Philips Lighting B.V. Page 10

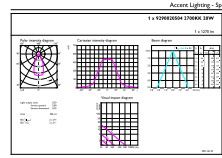

© Philips Lighting B.V. Page 11

General uniform lighting - MAS LEDspotLV D 20-100W 927 AR111 45D

Accent Lighting Spots - MAS LEDspotLV D 20-100W 927 AR111 45D

## Lifetime

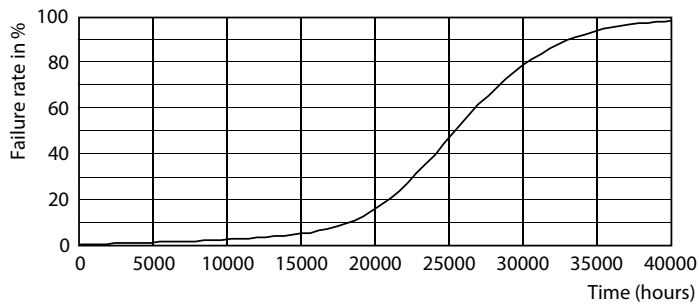

Life Expectancy Diagram - MAS LEDspotLV D 20-100W 927 AR111 45D

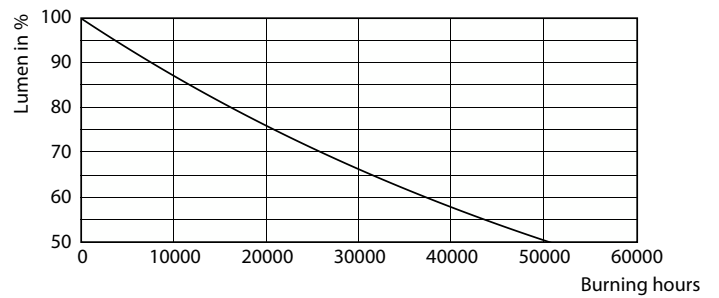

Lumen Maintenance Diagram - MAS LEDspotLV D 20-100W 927 AR111 45D

