



DynaVision Programmable Xtreme for SON

HID-DV PROG Xt 50 SON Q 208-277V

Highly reliable and flexible electronic drivers for SON lamps; designed to save energy via integrated controls, and to reduce maintenance costs thanks to 80,000-hour lifetime and integrated lightning protection. The DynaVision Programmable product family is the perfect basis for any sort of lighting management solution.

Product data

General Information	
Application Code	-
Type Version	-
Lamp Type	SON
Number of Lamps	1 piece/unit
Suitable For Outdoor Use	Yes
Number of Products on MCB (16A Type B) (Nom)	11
Default Lamp Selected	SON50
Automatic Restart	Yes
Operating and Electrical	
Input Voltage	208-240-277 V
Input Frequency	50 to 60 Hz
Minimum Mains Voltage Operation (Min)	172 V
Operating Frequency (Nom)	0.40 kHz
Power Factor 100% Load (Nom)	0.97
Ignition Voltage (Max)	5.0 kV

Ignition Switch-Off Time (Max)	20 min
Mains Voltage Performance (AC)	188-305V
Mains Voltage Safety (AC)	160-305V
Earth Leakage Current (Max)	0.7 mA
Output Peak Voltage (Max)	250 V
Inrush Current Width	0.24 ms
Lamp Power Tolerance	-3%/+3%
Input Current (Nom)	0.27 A
Inrush Current Peak (Nom)	28 A

Wiring	
Cable Capacity Output Wires Mutual (Nom)	1000 pF
Cable Length From Device to Lamp	10 m
Wire Striplength	10.0-11.0 mm
Ballast Contact Wire Cross Section	0.50-2.50 mm ²
Connector Type	WAGO series 804

DynaVision Programmable Xtreme for SON

System characteristics

Rated Ballast-Lamp Power	50 W
System Power on CDO	-
Lamp Power on CDO	-
Power Loss on CDO	-
Rated Lamp Power on Son	50 W
System Power on Son	56 W
Lamp Power on Son	50 W
Power Loss on Son	6 W
Power Loss on Son While Dimming	5 W

Temperature

T-Ambient (Max)	55 °C
T-Ambient (Min)	-30 °C
T-Storage (Max)	55 °C
T-Storage (Min)	-30 °C
T-Case Lifetime (Nom)	80 °C
T-Case Switch Off (Min)	92 °C

Controls and Dimming

Control Interface	PROG
Programmable Lamp Settings	CPO45/CPO60/SON50/SON70/CDO50/CDO70
Pre-Set Integrated Controls	Dali
Programmable Dimming Options	ALO/CLO/Dynadim/Lineswitch/AmpDim
Run-Up Time Before Dimming	10 min
Fade Down Rate	1.3 %/sec
Fade Up Rate	16.7 %/sec
Regulating Level	50%-100%

Mechanical and Housing

Housing	Q
---------	---

Approval and Application

Surge Protection (Common/Differential)	EN61547 (L-L 2kV, L-G 4kV), 10kV TIL kV
IP Classification Luminaire	34
Active Temperature Protection	Yes
EMI 9 kHz ... 300 MHz	CISPR 15 ed 7.2
EMI 30 MHz ... 1000 MHz	-
Safety Standard	IEC 607, 609, 926, 928 [No Standard for HID Lamp drivers exists. Requirements in these standards to be used if considered relevant for the product.]
Quality Standard	ISO 9000:2000
Environmental Standard	ISO 14001
Harmonic Current Emission Standard	IEC 61000-3-2
Vibration Standard	IEC 68-2-6 Fc (10-150Hz, 2G)
Bumps Standard	IEC 68-2-29 Eb (10G/16ms)
Humidity Standard	EN 61347-2-12 clause 11
Approval Marks	F-Marking CE marking ENEC certificate VDE-EMV certificate
Hum And Noise Level	< 30 dB(A)

Product Data

Full product code	871829166924100
Order product name	HID-DV PROG Xt 50 SON Q 208-277V
EAN/UPC - Product	8718291669241
Order code	66924100
Numerator - Quantity Per Pack	1
Numerator - Packs per outer box	12
Material Nr. (12NC)	913700693366
Net Weight (Piece)	0.820 kg

Dimensional drawing

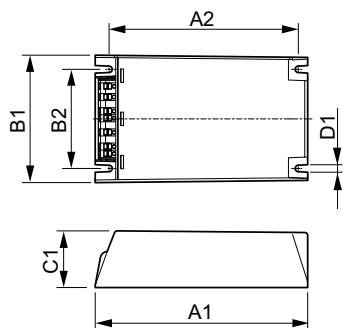

HID-DV PROG Xt 50 SON Q 208-277V

Product	D1	C1	A1	A2	B1	B2
HID-DV PROG Xt 50	4.5 mm	40.0	150.0	133.6	90.0	70.0
SON Q 208-277V		mm	mm	mm	mm	mm

DynaVision Programmable Xtreme for SON

