



MASTER LEDspot LV AR111

MAS LED ExpertColor 15-75W 940 AR111 24D

Delivering a warm, halogen-like accent beam, MASTER LEDspot LV AR111 is an ideal retrofit solution for spot and general lighting applications in the hospitality and retail industry. It is particularly suitable for general lighting where the light is on all the time, such as creative accent lighting applications in shops, restaurants, hotels, and especially for galleries, exhibitions and museums. The robustly designed MASTER LEDspot LV AR111 offers various beam angles for a clearly defined beam spread. There is no UV or IR in the beam, making it suitable for illuminating heat-sensitive objects (food, organic materials, paintings, etc.). The patented intelligent driver enables broad compatibility with existing electromagnetic and electronic halogen transformers. MASTER LEDspot LV AR111 delivers huge energy savings and minimizes maintenance cost without any reduction in brightness.

Product data

General Information	
Cap-Base	G53 [G53]
EU RoHS compliant	Yes
Nominal Lifetime (Nom)	40000 h
Switching Cycle	50000X
Technical Type	15-75W
Light Technical	
Colour Code	940 [CCT of 4000K]
Beam Angle (Nom)	24 °
Luminous Flux (Nom)	950 lm
Colour Designation	Cool White (CW)
Colour Temperature, horizontal (Nom)	4000 K
Luminous Efficacy (rated) (Nom)	63.00 lm/W

Color Consistency	<4
Colour Rendering Index horiz (Nom)	97
LLMF At End Of Nominal Lifetime (Nom)	70 %
Luminous Flux in 90° Cone (Rated)	950 lm
Operating and Electrical	
Input Frequency	- Hz
Power (Rated) (Nom)	15 W
Lamp Current (Nom)	1800 mA
Wattage Equivalent	75 W
Starting Time (Nom)	0.5 s
Warm Up Time to 60% Light (Nom)	0.5 s
Power Factor (Nom)	0.7

MASTER LEDspot LV AR111

Voltage (Nom)	ac electronic 12 V
Temperature	
T-Case Maximum (Nom)	74 °C
Controls and Dimming	
Dimmable	Yes
Approval and Application	
Energy Efficiency Label	A
Suitable For Accent Lighting	Yes
Energy Consumption kWh/1000 h	17 kWh

Product Data

Full product code	871869968708300
Order product name	MAS LED ExpertColor 15-75W 940 AR111 24D
EAN/UPC - Product	8718699687083
Order code	68708300
Numerator - Quantity Per Pack	1
Numerator - Packs per outer box	6
Material Nr. (12NC)	929002239202
Net Weight (Piece)	0.160 kg

Dimensional drawing

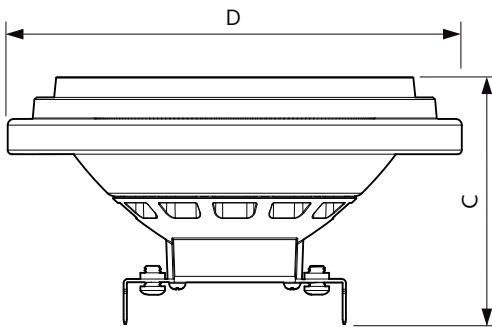

AR111 12V 15-75W 900lm 24D 4000K G53 D

Product	D	C
MAS LED ExpertColor 15-75W 940 AR111 24D	111 mm	62 mm

Photometric data

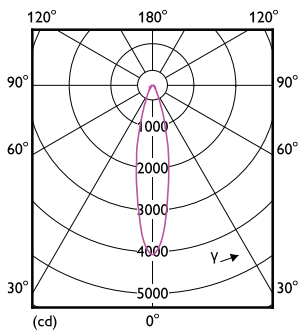

LEDspots 75W G53 AR111 940 24D

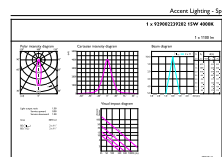

LEDspots 75W G53 AR111 940 24D

MASTER LEDspot LV AR111

Photometric data

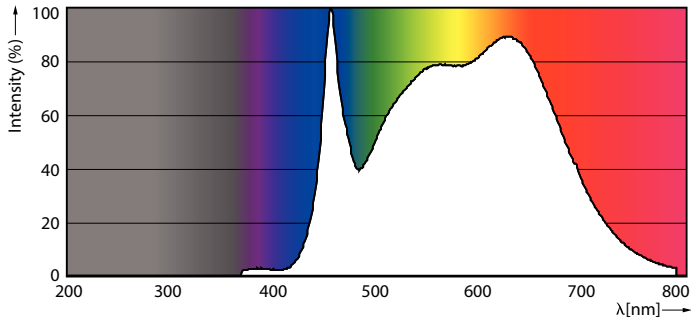

LEDspots 75W G53 AR111 940

Lifetime

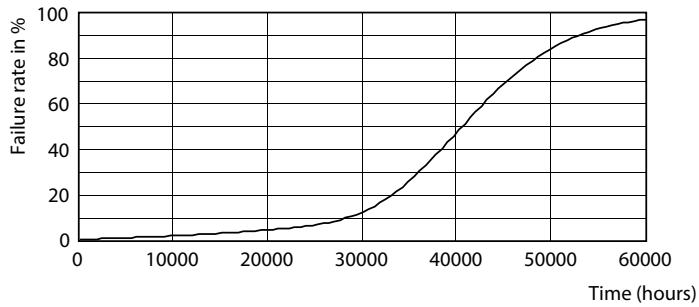

LEDspots LED 40K



LEDspots LMP 40K

